

QUICK START GUIDE

VF Series

Version: 1.0

Date: March, 2018

VF Series Quick Start Guide

Version: 1.0

1. Overview

Take VF300/380 as an example:

Front view

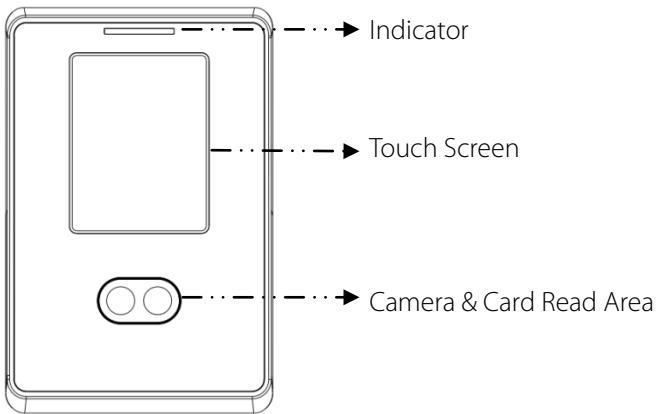

Left side view

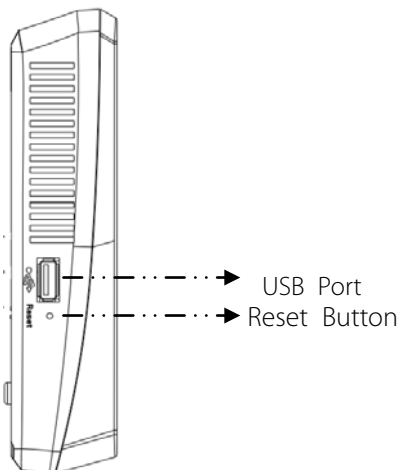

Rear view

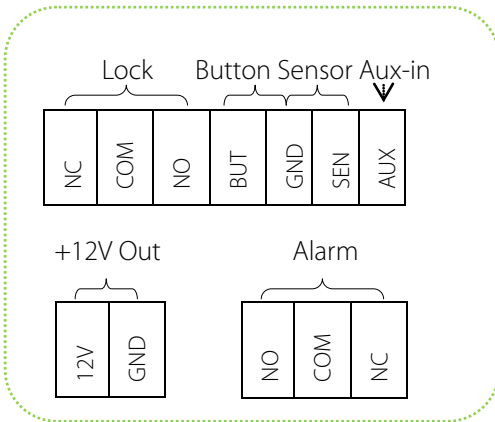
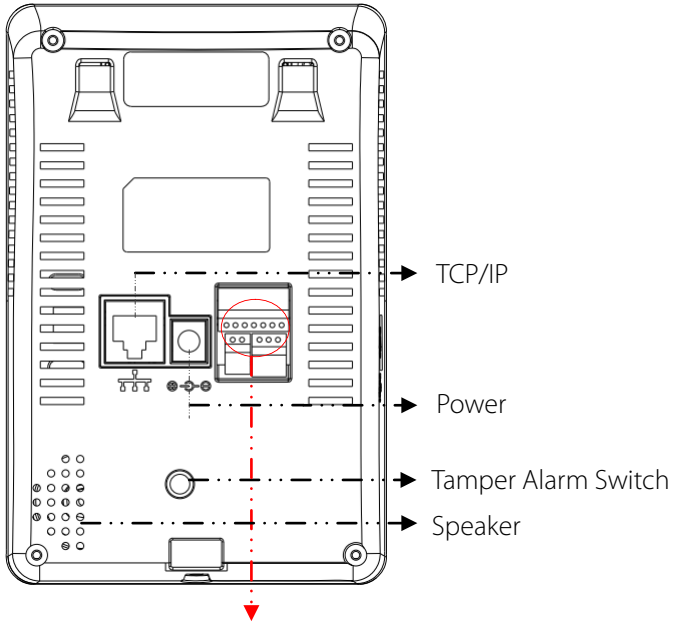

2. Installation Environment

➤ **Recommended location:**

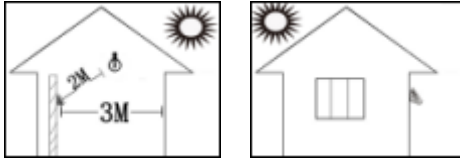

The device can be installed in indoor and outdoor places. Direct sunlight shall be avoided if the device is installed in outdoor places. Install the device indoors at least 10 feet (3m) away from windows, and 6.5 feet (2m) away from light fixtures.

➤ **Not recommended locations:**

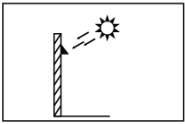

Direct sunlight outdoors

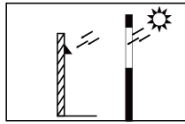

Direct sunlight through window

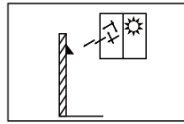

Indirect sunlight through window

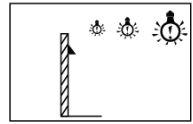

Too close to light fixtures

3. Installation Steps

Step1:

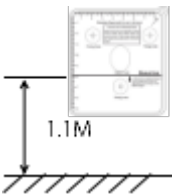

Affix the paper template to the wall and drill three holes within the three marked circles on the paper template.

We recommend affixing the template about 3.6 feet (1.1m) above the ground, assuming the average height of your users is 5-6 feet tall (1.55m-1.85m).

The installation height 4 feet (1.2m) is applicable for the body height over 5.4 feet (1.65m).

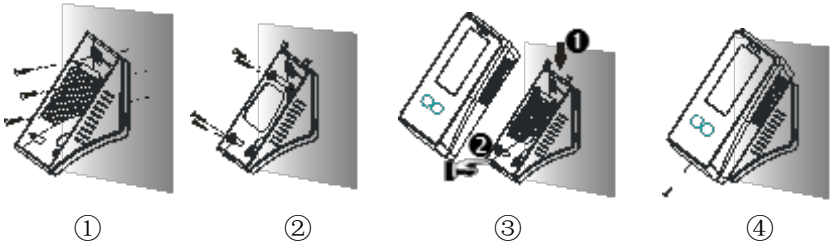

Step2:

Align the wall mounted base to the holes on the wall, and use three screws to fix it onto the wall (figure①); align the iron board to the holes on the wall mounted base, and use four screws to fix it onto the wall mounted base (figure②); connect the device with the iron board (from the top down), to ensure it is tightly jointed with the board (figure③); finally use one screw to fix the device and the iron board (figure④).

4. Cautions

➤ Recommended standing position:

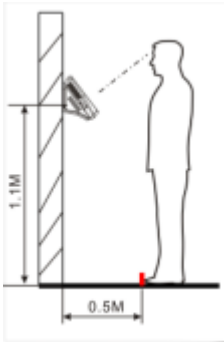

For users 5-6 feet tall (1.55m-1.85m) we recommend users stand about 2 feet (0.5m) from the wall.

When viewing your image on the device display window, step away if your image appears too bright. Step closer if your image appears too dark.

1) Recommended:

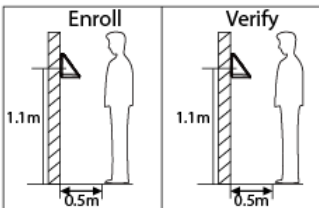

When enrolling users and then subsequently verifying those users, it's important those users consistently stand (or sit) at the same distance and angle from the device.

2) Several wrong ways:

Different posture

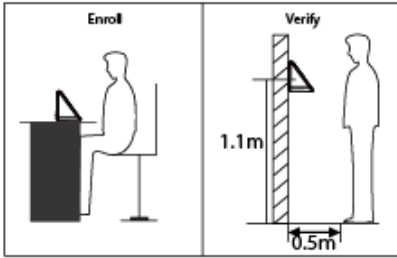

Different height

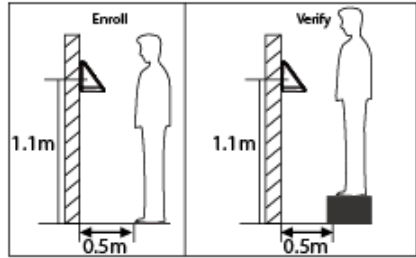

Too close

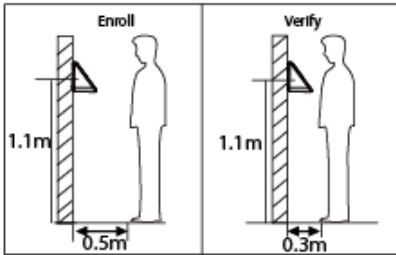

Too far

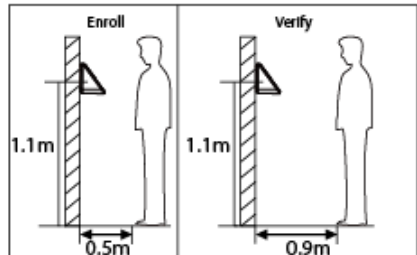

➤ **Enrollment and verification:**



During the enrollment, follow the voice prompts by focusing eyes inside the green box. The user needs to move the face up or down during face registration. The pose for registration is shown in the figure above.

During the verification, position your head such that your face appears in the center of the device display window. Focus your face inside the green box.



5. Troubleshooting

- The face cannot be recognized by the device in verification.

Solutions:

- 1) Check if your facial expression, standing posture and distance during verification are the same with that in enrollment.
 - 2) Check if the device is under direct sunlight or near the windows.
- Verification fails as user wears glasses during verification but not in face enrollment.

Solution: You can enroll your face wearing glasses in the first or second time of face capturing, since the device supports 3 times of capturing face templates.

- The device makes a misjudgment in verification.

Solution: There is a certain probability of misjudgment. You can re-enroll your face.

ZK Building, Wuhe Road, Gangtou, Bantian, Buji Town,
Longgang District, Shenzhen China 518129
Tel: +86 755-89602345
Fax: +86 755-89602394
www.zkteco.com

